

PE-N14AA 14.7W

PE-N20AA 21W



5 years     **RoHS SELV CE Class 2**



Features:

1. integrate multiple signal dimming interfaces
2. digital control output without stroboscopic
3. AC input 100-250v range
4. natural air cooling, moisture-proof, heat conducting silicone heat dissipation process
5. deep dimming design
6. multiple protection functions
7. crimping design, convenient and fast

Application:

1. Led monochrome light source
2. villa intelligent lighting
3. wireless intelligent lighting system can be accessed
4. museum lighting
5. high end commercial lighting

General description:

1. the CPU is used to control the dimming curve and the mixed frequency control to achieve the visual angle perception brightness. The raw materials used are first-line brands and imported chips are designed for ultra deep dimming, it matches a variety of intelligent dimming systems on the market, accurately controls the brightness, comes with a slow start-up and ultra small size design

Specification:

Model		PE-N14AA42	PE-N14AA24	PE-N20AA42	PE-N20AA24
OUTPUT	Output Voltage	9-42Vdc	9-24Vdc	9-42Vdc	9-24Vdc
	Max Output Voltage	42Vdc	24Vdc	42Vdc	24Vdc
	Non-load Output Voltage	53Vdc	33Vdc	53Vdc	33Vdc
	Output Current	150/180/200/250 /280/300/320/350mA	200/250/280/300 /350/400/450/500mA	200/250/280/300 /350/400/450/500mA	450/500/550/600 /650/700/750/800mA
	Output Power	2W~14.7W	2W~12W	2W~21W	4W~19.2W
	Strobe Level	No Flicker			
	Dimming Range	0~100%, LEDstart at 0.3%possible.			
	PWM Dimming Frequency	>3600Hz			
	Current Accuracy	±5%			
	Power down mode	No signal maximum brightness output			
INPUT	Dimming Interface	0-10V 1-10V signal interface current <2ma / PUSH(P1 P2)			
	Input Voltage Range	100-250Vac			
	Frequency	50/60Hz			
	Input Current	<0.14A ac230v		<0.23A ac230v	
	Power Factor	PF>0.95/230V ac(at full load)		PF>0.96/230V ac(at full load)	
	THD	230Vac@THD <10% (at full load)			
	Efficiency(typ.)	82%		84%	
	Inrush Current(typ.)	cold start30A@230Vac			
	Anti Surge	L-N: 1.5kV			
	Leakage Current	<0.25mA/230Vac			
ENVIRONMENT	Working Temperature	ta: 45°C tc: 80 °C			
	Working Humidity	20 ~ 95%RH, non-condensing			
	Storage Temp., Humidity	-40 ~ 80°C, 10~95%RH			
	Temp.Coefficient	±0.03%/°C(0-50)°C			
	Vibration	10~500Hz, 2G 12min./1cycle, period for 72min. each along X, Y, Z axes.			
PROTECTION	Over-heat Protection	Intelligently adjusting or turning off the output current if the PCB temperature ≥110°C, , auto recovers.			
	Over Load Protection	Shut down the output when rated power≥102%, auto recovers.			
	Short Circuit Protection	Shut down automatically if short circuit occurs, auto recovers.			
	Non-load Protection	output Constant Voltage.			
SAFETY & EMC	Withstand Voltage	I/P-O/P: 3750Vac			
	Isolation Resistance	I/P-O/P: 100MΩ/500VDC/25°C/70%RH			
	Safety Standards	IEC/EN61347-1, IEC/EN61347-2-13			
	EMC Emission	EN55015, EN61000-3-2 Class C, IEC61000-3-3			
	EMC Immunity	EN61000-4-2,3,4,5,6,8,11, EN61547			
OTHERS	Strobe Test Standard	IEEE 1789			
	Dimension	127.5(97)×43×30mm(L×W×H)			
	Packing	Box			
	Weight(G.W.)	192g±10g			

Dimensions :

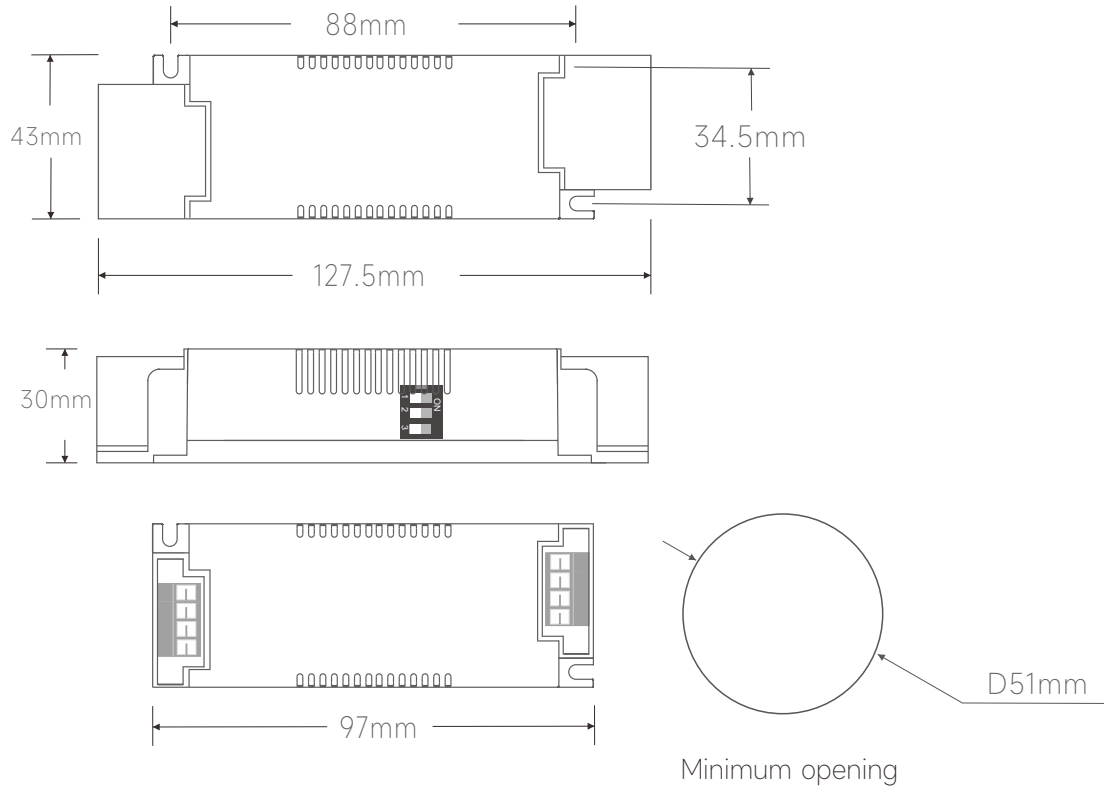

Product Label:

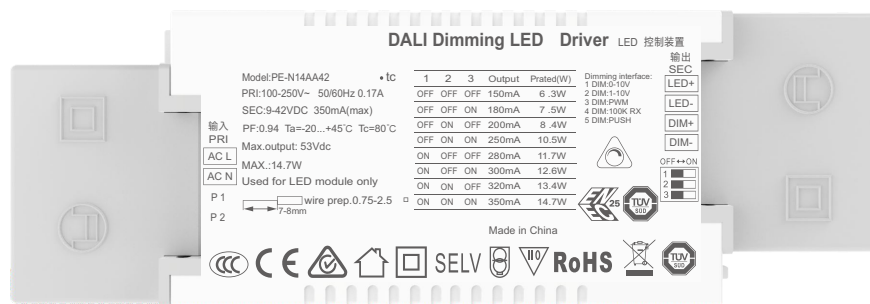

LED Current Selection:

DIP switch for 8 optional currents' quick selection.

Product model	DIP Switch								
PE-N14AA42	Output Current	150mA	180mA	200mA	250mA	280mA	300mA	320mA	350mA
	Output Voltage	9-42V	9-42V	9-42V	9-42V	9-42V	9-42V	9-42V	9-42V
	Output Power	1.3W-6.3W	1.6W-7.6W	1.8W-8.4W	2.2W-10.5W	2.5W-11.7W	2.7W-12.6W	2.8W-13.4W	3.15W-14.7W
PE-N14AA24	Output Current	200mA	250mA	280mA	300mA	350mA	400mA	450mA	500mA
	Output Voltage	9-24V	9-24V	9-24V	9-24V	9-24V	9-24V	9-24V	9-24V
	Output Power	1.8W-4.8W	2.2W-6W	2.5W-6.7W	2.7W-7.2W	3.1W-8.4W	3.6W-9.6W	4W-10.8W	4.5W-12W
PE-N20AA42	Output Current	200mA	250mA	280mA	300mA	350mA	400mA	450mA	500mA
	Output Voltage	9-42V	9-42V	9-42V	9-42V	9-42V	9-42V	9-42V	9-42V
	Output Power	1.8W-8.4W	2.2W-10.5W	2.5W-11.7W	2.7W-12.6W	3.1W-14.7W	3.6W-16.8W	4W-18.9W	4.5W-21W
PE-N20AA24	Output Current	450mA	500mA	550mA	600mA	650mA	700mA	750mA	800mA
	Output Voltage	9-24V	9-24V	9-24V	9-24V	9-24V	9-24V	9-24V	9-24V
	Output Power	4W-10.8W	4.5W-12W	4.9W-13.2W	5.4W-14.4W	5.8W-15.6W	6.3W-16.8W	6.7W-18W	7.2W-19.2W



Dimensions :

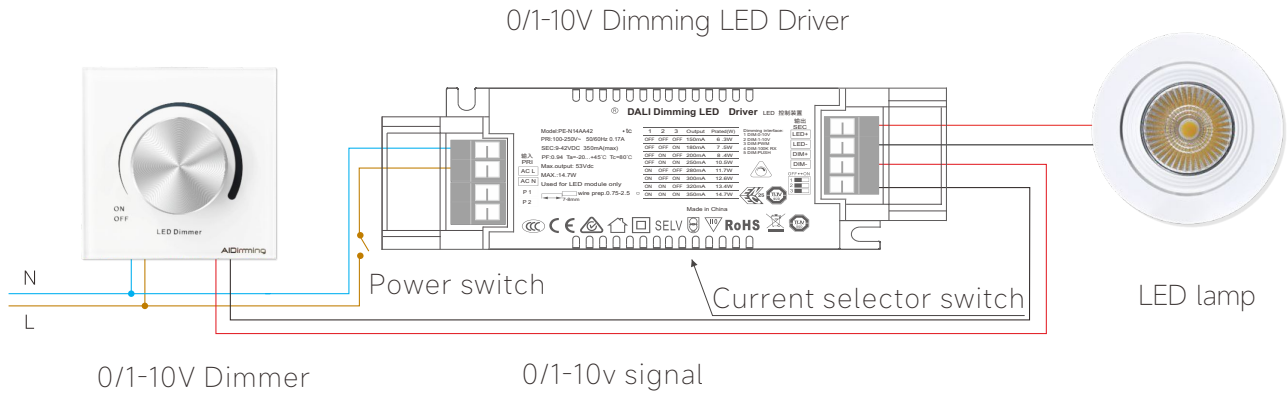

Note: it is forbidden to connect the signal control interface with a voltage higher than 15V, otherwise the power supply will be damaged

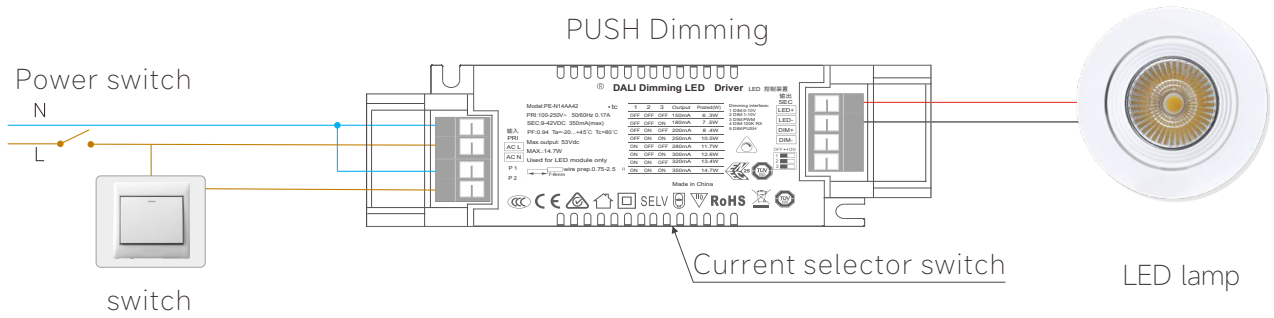

Wiring:

1. Input terminal wiring: suitable for wire gauge 22awg-14awg (0.5mm² – 1.5mm²), stripping requires 9-10mm tin
2. Output terminal wiring: suitable for wire gauge 22awg-12awg (0.5mm² – 1.5mm²), stripping requires 6-7mm tin

Working Curve:

distortion characteristic curve

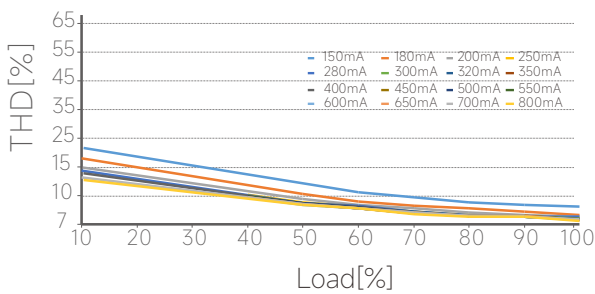

PF characteristic curve

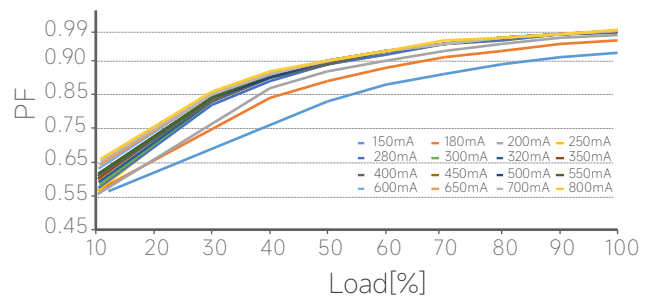

Efficiency VS Load

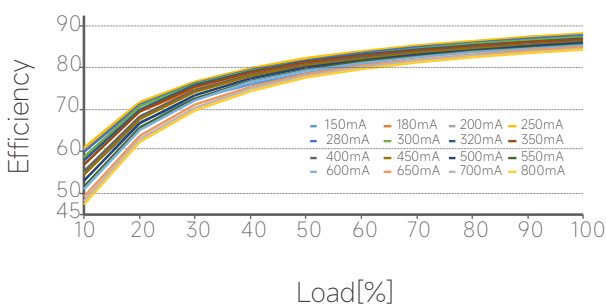

Current VS Voltage

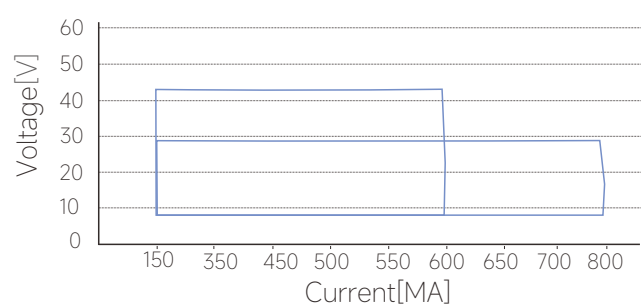

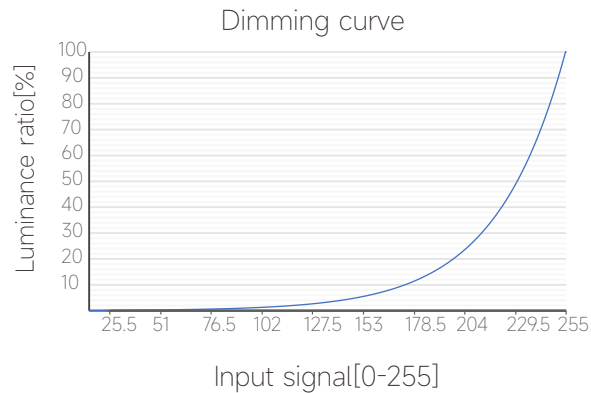

The use of guidance:

Unless otherwise specified, all specifications and parameters are measured at 230VAC input, rated load and 25 °C Ambient Temperature

This product has a press line cap at the input, with self-locking clamping, it can be opened up with a screwdriver, then you will see the input terminal connected with the AC line L and the null lime N, The output terminal connect a according to the product label, notice the positive and negative pole.

**1:please pay attention to the distinction between input and out put , connect correctly, then power on

**2:please connect first the load of the DC output, open the driver after checking; in the constant current mode, if power on at open circuit, please turn off the driver and can't connect the LED until the electric energy stored by the output release, or it may damage the LED ;

**3.this type of driver is only limited to the use of the LED lamps ,the input voltage range is AC100-250V,the heat insulation cotton and other items that obstruct the heat dissipation of the product, which conforms to the product under the specified output voltage, current range, the use environment temperature is -20-45 degrees, and the surface can not cover the conditions of the environment, this product enjoys 5 years of free warranty.

1.the LED lamp doesn't bright after the dimming driver is connected at the first time, please turn off the AC input and check as follow:

- 1)whether or not DC output bad contact;
- 2)whether DC output polarity is reversed, or the LED board is welded anti;
- 3)whether AC input is bad contact, test after eliminating these failures;

2.the device has good connection, LED lights, but the LED flicker, please turn off the AC input and check as follow:

- 1).whether or not the parameters and actual parameters match.
- 2).please timely communicate with us if you have any questions in the using, we will try our best to solve the problems with you.

Difference between 0-10V and 1-10V:

- 1.When the 0 / 10V dimmer is adjusted to the maximum 10V, the output current will reach 100% of the power output, and the brightness will reach 100%. When the 0-10V dimmer is adjusted to 0V,the current will be the minimum, and the light will be turned off; When the 1-10V dimming is adjusted to 1V, the current is the minimum and the light is off.
- 2.Difference between 0-10V and 1-10V dimming: different starting and closing voltage, 0-10V is on at 0.7V, (the min brightness) 1-10V is on at 1.2V (the min brightness).
- 3.Digital dimming driver 0-10V and 1-10V dimming automatic identification two dimming modes.
- 4.The same signal circuit controls light and dark at the same time.
- 5.Dimmer (dimming system) is divided into 0-10V and 1-10V dimming signals.
- 6.Dimming compatibility is related to the control distance of signal line and the number of control power supply. If the number is too large or the signal line is too long, problems such as can not adjusted lower and can not adjusted off will occur.

Product warranty scope:

1. the signal control interface shall not be connected to a voltage higher than 15V to damage the power supply
2. input and output connections are reversed, resulting in power damage
3. the power supply is damaged due to water ingress

Statement:

The pictures and specifications are for reference, subject to the real object.
If there is any change in the specifications, it will be notified separately.